



RECESS®

3D^{EPS}

**DECORATIVE
WALL PANELS**

Interior Et Exterior



+90 212 672 89 72

www.verlass.com.tr

Powered by
VERLASS
CONSTRUCTION AND CHEMICALS

RECESS®

WALL PANELS & FRAME GROUP



About use

Verlass Construction and Chemical Industry, with years of experience in the sector, effectively contributes to the construction sector with the well-known and trusted RECESS[®]™ brand. By widening its target to the global market with the proprietary RECESS[®]™ brand, Verlass meets all requirements of the Construction Industry Products including Construction Chemicals, Pressure Concrete, Wall Panels, Wall Ornaments, Construction and Industrial Paints under one roof. Today, Verlass is in the progress of adding value to its clients with innovative and specialized products ranging across 20 different product lines. Verlass Construction and Chemical Industry provides high-level service to its international trade partners ranging across 41 countries with the philosophy of “Continuous Development is the Key to Success”, utilizing the operation centre located in Turkey, and doing business with innovative, trustworthy, pursuing, honest, customer satisfaction-oriented values. Verlass adds value to the customer by prioritizing the principles of quality, prompt response to the needs and the service provided by the expert technical team both presale and after-sale. Verlass Construction and Chemical Industry takes firm steps toward being an innovative and leading firm by adding value to the construction and vehicle repair businesses in both Turkey and the World with its Research and Development activities and Technical Support provided in production facilities in Istanbul.

Our Vision

We give primary importance to the principle of adding value to the client by high-quality, responsive and qualified pre-and after sales services of the technical team.

Our Mission

Verlass structure and chemical industry proceeds on its way to be one of the innovative and pioneer companies that adds value to construction industry with production facilities in Istanbul, ongoing R & D activities in Turkey and in the world and technical support provided.

RECESS™ logosu ve markası Verlass Yapı ve Kimya San. Tic. Ltd. Şti.'nin ticari ve tescilli markasıdır. Her hakkı Saklıdır.
The RECESS™ logo and brand is Verlass Construction and Chemical Trade Ltd. Company's commercial and proprietary trademark. All rights reserved.

RECESS®

3D^{EPS}

**DECORATIVE
WALL PANELS**

Interior & Exterior



RCS 006
1200mm x (h)600mm x 40mm



RCS 009
1200mm x (h)600mm x 40mm



RCS 010
1200mm x (h)600mm x 40mm

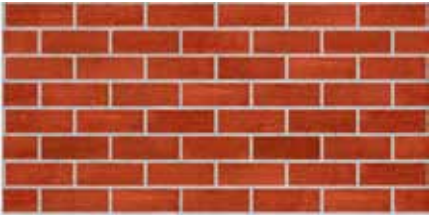

RCS 013
1200mm x (h)600mm x 40mm



RCS 012
1200mm x (h)600mm x 40mm

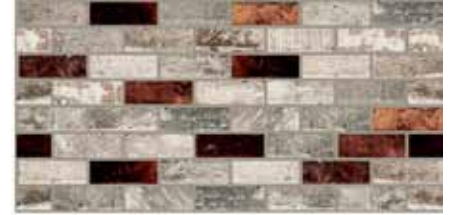

RCS 014
1200mm x (h)600mm x 40mm



RCS 015
1200mm x (h)600mm x 40mm





RCS 005

1200mm x (h)600mm x 40mm



RCS 008

1200mm x (h)600mm x 40mm



RCS 001

1200mm x (h)600mm x 40 mm



RCS 011

1200mm x (h)600mm x 40mm



RCS 004

1200mm x (h)600mm x 40mm



RCS 003

1200mm x (h)600 mm x 40mm

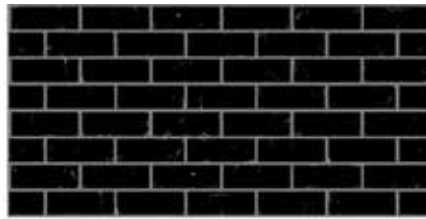

RCS 007

1200mm x (h)600mm x 40mm

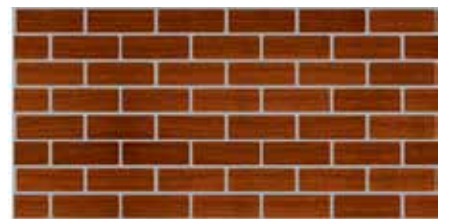

RCS 002

1200mm x (h)600mm x 40 mm





RCS 0025

1200mm x (h)600mm x 40 mm



RCS 0016

2000mm x (h)600mm x 40mm



RCS 0023

2000mm x (h)600mm x 40mm



RCS 0020

2000mm x (h)600mm x 40mm



RCS 0021

2000mm x (h)600mm x 40mm



RCS 0026

2000mm x (h)600mm x 40mm



RCS 0017

2000mm x (h)600mm x 40mm



RCS 0027

2000mm x (h)600mm x 40mm



RCS 0016

2000mm x (h)600mm x 40mm





RCS 0019
2000mm x (h)600mm x 40mm



RCS 0024
2000mm x (h)600mm x 40mm

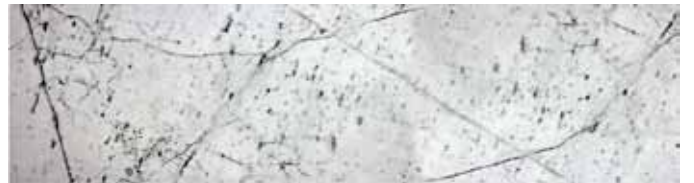

RCS 0022
2000mm x (h)600mm x 40mm



RCS 0028
2000mm x (h)600mm x 40mm



RCS 0029
2000mm x (h)600mm x 40mm



RCS 0030
2000mm x (h)600mm x 40mm



RCS 0031
2000mm x (h)600mm x 40mm



RCS 0034
2000mm x (h)600mm x 40mm





RCS 035

2000mm x (h)600mm x 40mm



RCS 036

2000mm x (h)600mm x 40mm

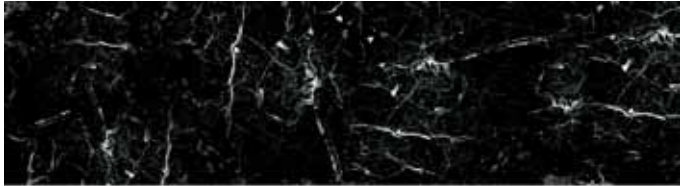

RCS 033

2000mm x (h)600mm x 40mm



RCS 037

2000mm x (h)600mm x 40mm

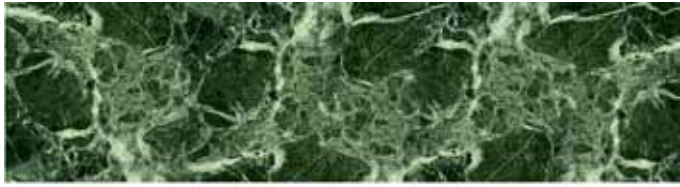

RCS 032

2000mm x (h)600mm x 40mm



RCS 038

2000mm x (h)600mm x 40mm



Wood



RCS 039
2000 x (h)600 x 40mm



RCS 0040
2000mm x (h)600mm x 40mm



RCS 0041
2000mm x (h)600mm x 40mm



RCS 0043
2000mm x (h)600mm x 40mm



RCS 0042
2000mm x (h)600mm x 40mm



RCS 0045
2000mm x (h)600mm x 40mm



RCS 0044
2000mm x (h)600mm x 40mm



RCS 0047
2000mm x (h)600mm x 40mm



RCS 0046
2000mm x (h)600mm x 40mm



RCS 0048
2000mm x (h)600mm x 40mm





RCS 0049

2000mm x (h)600mm x 40mm



RCS 0061

2000mm x (h)600mm x 40mm



RCS 0055

2000mm x (h)600mm x 40mm



RCS 0051

2000mm x (h)600mm x 40mm



RCS 0053

2000mm x (h)600mm x 40mm



RCS 0057

2000mm x (h)600mm x 40mm



RCS 0062

2000mm x (h)600mm x 40mm



RCS 0052

2000mm x (h)600mm x 40mm



RCS 0056

2000mm x (h)600mm x 40mm



Wood



RCS 0058
2000mm x (h)600mm x 40mm



RCS 0060
2000mm x (h)600mm x 40mm



RCS 0054
2000mm x (h)600mm x 40mm



RCS 0050
2000mm x (h)600mm x 40mm



RCS 0059
2000mm x (h)600mm x 40mm



RCS 0063
2000mm x (h)600mm x 40mm





RCS 101
2000mm x (h)480mm x 40mm



RCS 102
2000mm x (h)480mm x 40mm



RCS 0066
2000mm x (h)480mm x 40mm



RCS 103
2000mm x (h)480mm x 40mm



RCS 064
2000mm x (h)480mm x 40mm



RCS 100
2000mm x (h)480mm x 40mm



RCS 065
2000mm x (h)480mm x 40mm



RCS 104
2000mm x (h)480mm x 40mm



RCS 0067
2000mm x (h)480mm x 40mm





RCS 0069

1200mm x (h)500mm x 40mm



RCS 0070

1200mm x (h)500mm x 40mm



RCS 0072

1200mm x (h)500mm x 40mm



RCS 0068

1200mm x (h)500mm x 40mm



RCS 0071

1200mm x (h)500mm x 40mm



RCS 073
1200mm x (h)500mm x 40mm



RCS 075
1200mm x (h)500mm x 40mm



RCS 077
1200mm x (h)500mm x 40mm



RCS 0074
1200mm x (h)500mm x 40mm



RCS 0076
1200mm x (h)500mm x 40mm



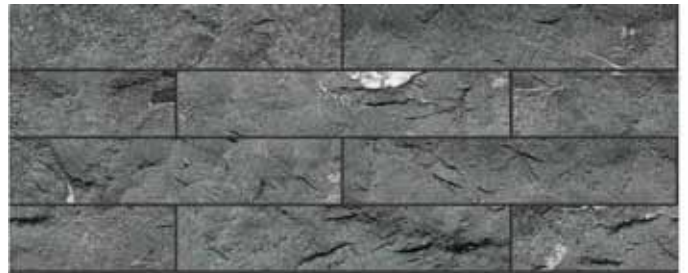

RCS 0078

1200mm x (h)500mm x 40mm



RCS 0079

1200mm x (h)500mm x 40mm



RCS 0081

1200mm x (h)500mm x 40mm



RCS 0082

1200mm x (h)500mm x 40mm



RCS 0080

1200mm x (h)500mm x 40mm



RCS 104

1200mm x (h)500mm x 40mm



RCS 0083

1200mm x (h)500mm x 40mm



RCS 0084

1200mm x (h)500mm x 40mm



RCS 0085

1200mm x (h)500mm x 40mm



RCS 0086

1200mm x (h)500mm x 40mm





RCS 0092
1200mm x (h)500mm x 40mm



RCS 090
1200mm x (h)500mm x 40mm



RCS 0091
1200mm x (h)500mm x 40mm

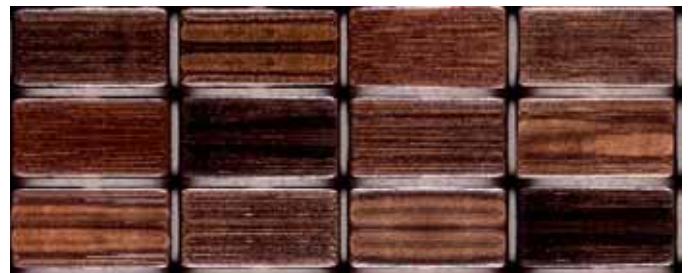

RCS 088
1200mm x (h)500mm x 40mm

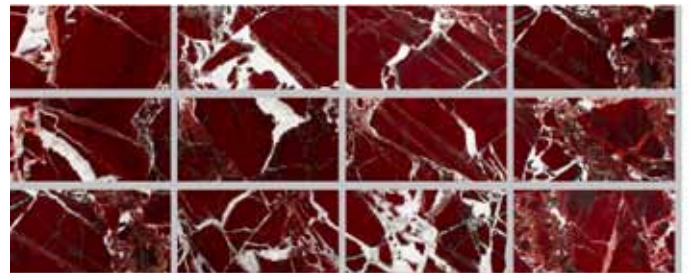

RCS 087
1200mm x (h)500mm x 40mm



RCS 0093
1200mm x (h)500mm x 40mm



RCS 0089
1200mm x (h)500mm x 40mm



RCS 0094
1200mm x (h)500mm x 40mm



RCS 0095
1200mm x (h)500mm x 40mm



RCS 0096
1200mm x (h)500mm x 40mm





RCS 0097
1350mm x (h)550mm x 40mm

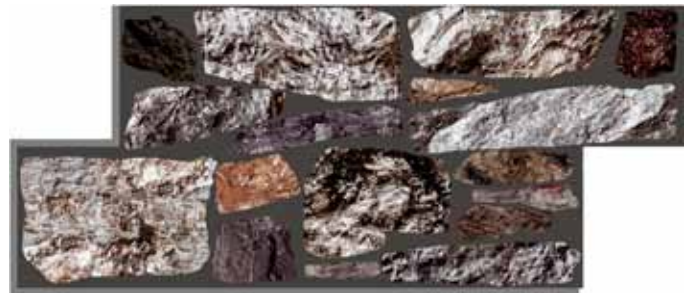

RCS 0099
1350mm x (h)550mm x 40mm

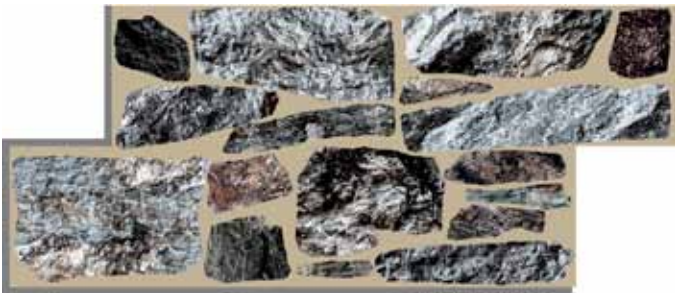

RCS 0098
1350mm x (h)550mm x 40mm

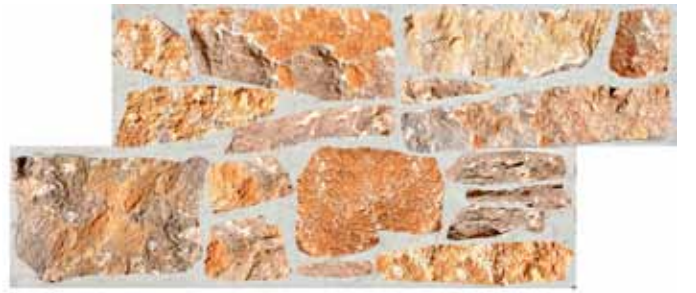

RCS 105
1350mm x (h)550mm x 40mm





Specifications

Panels, EPS blocks, EPS occurs as a result of the fabrication process and various technical features. EPS expanded polystyrene rigid foam (EPS - expanded polystyrene Foam),oil obtained from polymerization of styrene monomer,typically white colored thermoplastic material in the form of a foam with closed pores.

The use of used as decoration as well as insulation and sound insulation.



Flexible structure, thanks to its shock-absorbing properties and mechanical strength, can be used safely.

The water absorption rate is very low, because even if directly in contact with water does not change. In this way, they are unaffected by moisture and humidity. Other insulation materials, according to both the following both in the production phase in the process is environmentally friendly and ozone layer-damaging CFCs in the production, etc. does not contain.

It is resistant against the formation of bacteria and anti-bacterial. Sheathing plates as compared to the application is much simpler, does not require mastery.

Class B1 flame-and fire-resistant raw materials are produced while playing.

By mounting in a very short time, especially for hotel, cafe, restaurant, shops, spaces for commercial establishments that require a change of decoration in such as a time-saving, practical and impressive solution.

It loses its insulating properties.

Can be easily mounted to any desired surface, statics, does not affect use in any way, and the front has an extra burden to a uniquely light product. They are also easily disassembled feature minimizes the cost of dismantling.

Image and eliminates the disadvantages of natural stone natural stone texture and effect it will give.

Natural stone in applications with temperature occurring on the surface of the stone bar formation, rupture and eliminates negative situations, such as regional fragmentation.

Frequently Asked Questions

What are Recess Decorative Wall Panels?

Recess Decorative Wall Panel is a product that provides sound and thermal insulation. It is composed of EPS (Styrofoam) + Impact and Exterior Environment Resistant Coating + Special Paint + Protective Layer of Varnish and it brings a visually appealing touch to your buildings.

Do I have to install insulation before applying Recess Decorative Wall Panels?

You do not have to install insulation before applying Recess Decorative Wall Panels. One of Recess Decorative Wall Panels' components is EPS, which is the main component in insulation.

Since Recess Decorative Wall Panels provide Thermal insulation it can be used as an insulation material.

Do you provide installation services?

In case you need an installation team we can direct you to Recess dealers who are experts in their fields.

What is the working life of Furpaz Decorative Wall Panels?

The working life of Recess Decorative Wall Panels is equal to that of your building.

Can I hang pictures, TV units and etc. on Furpaz Decorative Wall Panels?

As Recess Decorative Wall Panels can be drilled and cut you can hang anything on them.

Can you help me with how the final form of the project will look if I use Recess Decorative Wall Panels?

Our project teams are ready to serve you with a 3D design of how the finished project will look.

Do your products have any bad effects on human health?

All of our products carry European Standard CE documentation. Our products have no threat against your health or the environment.

Can I use Furpaz Decorative Wall Panels on Interior Walls?

You can easily use Recess Decorative Wall Panels inside as well. Our products can be built in different thickness for interior as it can be for exterior use. You would not only be creating a visually appealing environment but would also be adding sound insulation to your building. If your building does not already have exterior insulation; you would also be installing thermal insulation to your building.

Can I use Recess Decorative Wall Panels on the floor or the ceiling?

With the right bonding agent you may apply Recess Decorative Wall Panels, which serve primarily as thermal insulation and decorative material to your ceiling and give it a brick, marble or wooden look. Our products cannot be used as a subsidiary for marble, hardwood

or any other material on the floor.

Do Recess Decorative Wall Panels provide sound insulation?

Recess Decorative Wall Panels provide sound insulation.

To what extent are Furpaz Decorative Wall Panels durable against water, moisture and sunlight?

Our products are not affected from water and moisture. Our protective layer also provides protection against UV rays.

Can I paint over Recess Decorative Wall Panels?

If you happen to want to change the color of your walls, you may paint over Recess Decorative Wall Panels.

Why should I choose Furpaz Decorative Wall Panels over natural stone, hardwood or marble?

Compared to natural hardwood, stone or marble; Recess Decorative Wall Panels are extremely light. For that reason it does not add extra weight to the load-bearing system of the building. It is very simple and easy to install. As it takes less time to install, it is a time saving, practical and effective solution especially in business use such as cafes, gyms, shops and hotels. It is also more preferable as it does not create any construction waste during installation.

Can I use Recess Decorative Wall Panels instead of Insulation?

Recess Decorative Wall Panels provide thermal insulation and is used as an insulation material. When you choose Recess Decorative Wall Panels you also add a decorative touch to your building.

Do the products demand extra care or maintenance after they are installed?

As Recess Decorative Wall Panels can be wiped and washed they do not demand extra maintenance.

Can we cut the panels in any size we want?

You may easily cut the panels according to your needs with a saw, craft knife or a similar object.

Can I safely use Recess Decorative Wall Panels in extremely hot or cold temperatures?

Our products are meant to withstand hot and cold weathers so you may use them safely. Since these products provide insulation they will reduce your air-conditioning costs as well.

Are Recess Decorative Wall Panels fire resistant?

Recess Decorative Wall Panels are B1 class fire proof.

Do Furpaz Decorative Wall Panels have a warranty?

Apart from installation errors, malicious use, exterior impacts and natural disasters; Recess Decorative Wall Panels are under our warranty for manufacturing defects and possible color changes due to sunlight exposure.







PS-01



PS-02



PS-03



PS-04

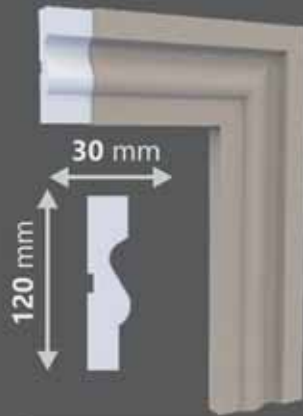

PS-05

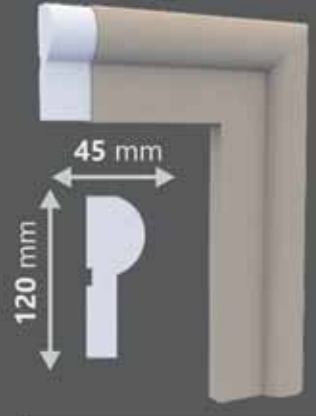

PS-06



PS-07



PS-08

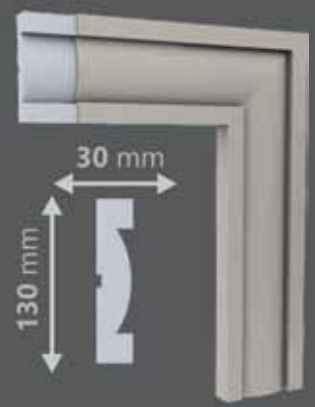

PS-09

Window Frames



PS-10

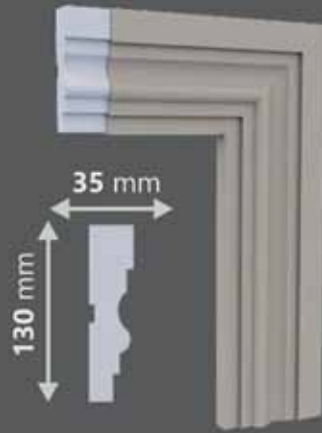

PS-11

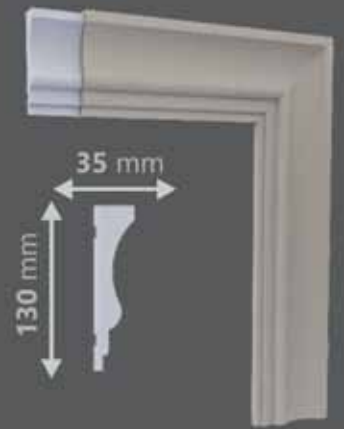

PS-12

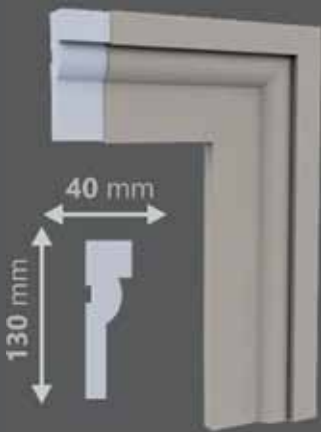

PS-13



PS-14

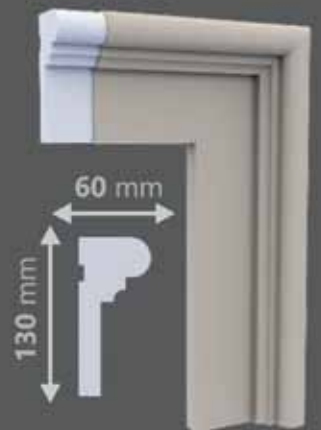

PS-15



PS-16



PS-17

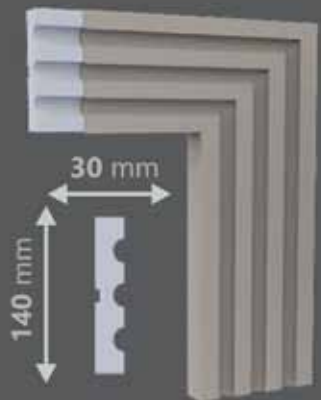

PS-18

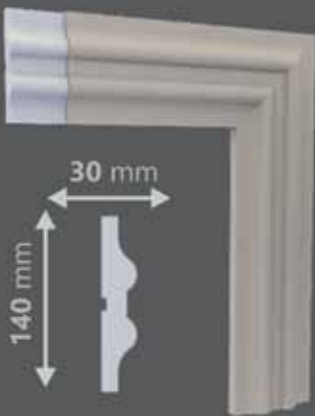

PS-19

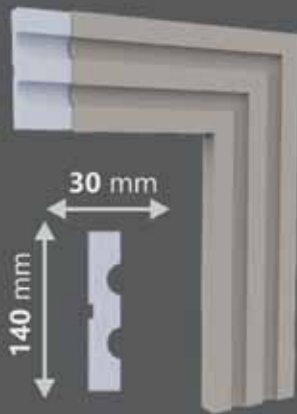

PS-20

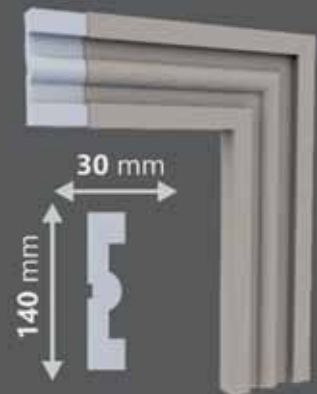

PS-21



PS-22



PS-23

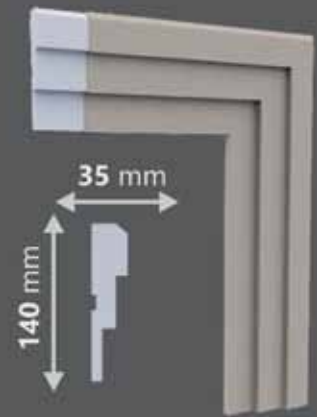

PS-24



PS-25



PS-26



PS-27

Window Frames

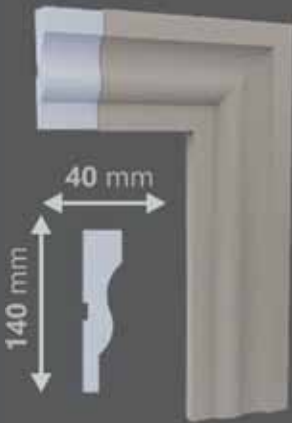

PS-28

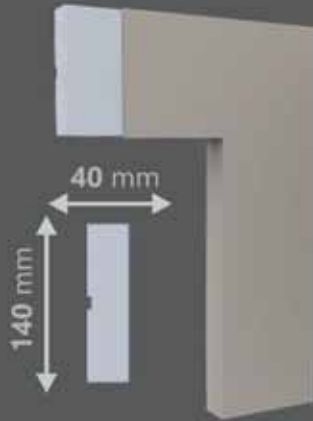

PS-29

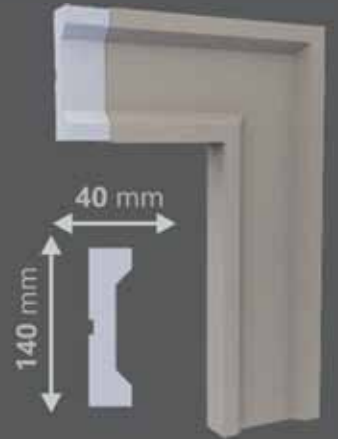

PS-30

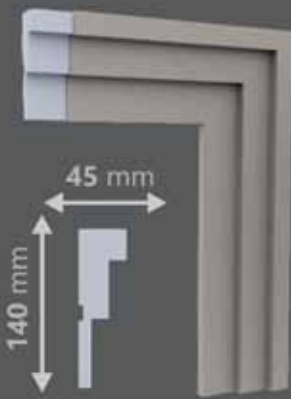

PS-31

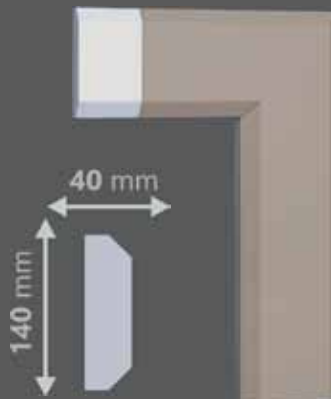

PS-32

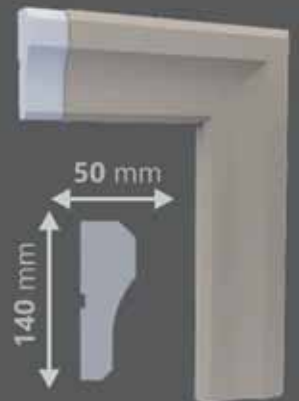

PS-33



PS-34

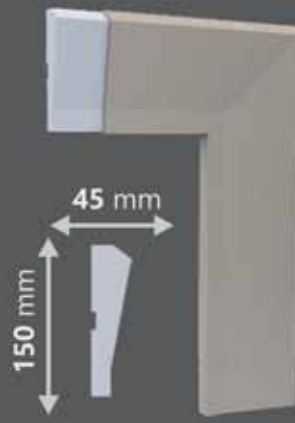

PS-35

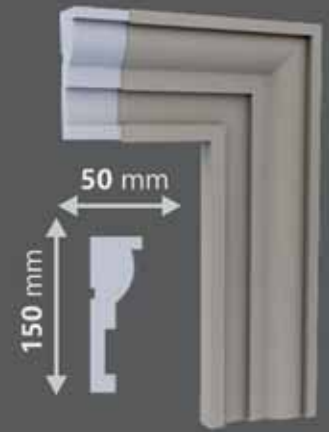

PS-36





DS-01

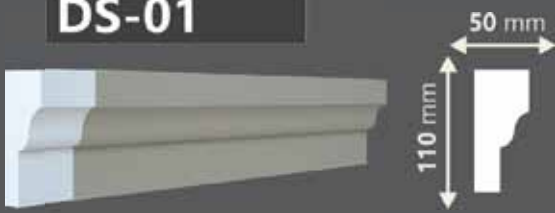

DS-02



DS-03



DS-04

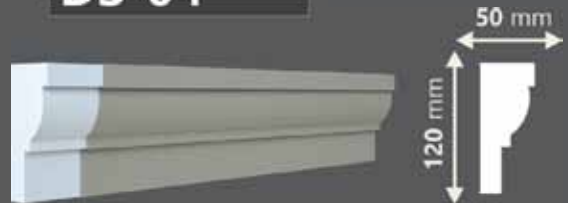

DS-05



DS-06



DS-07



DS-08



DS-09



DS-10







KT-01

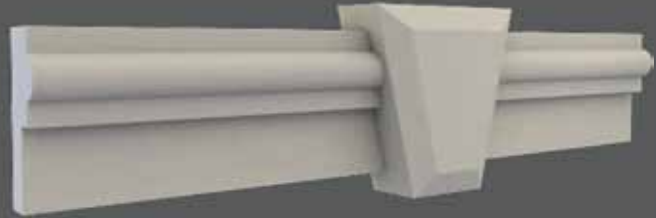

KT-02

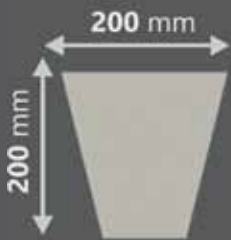
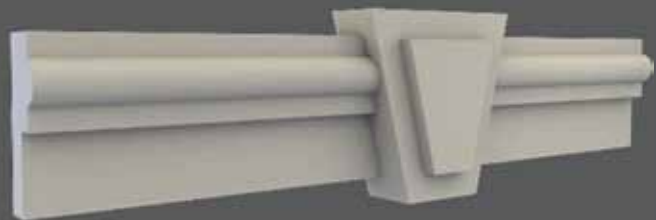

KT-03

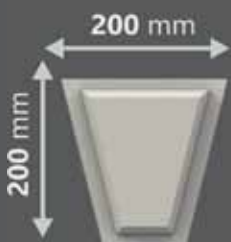
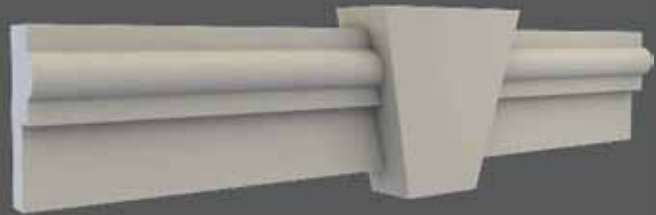

KT-04

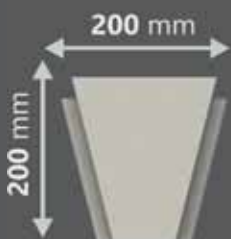
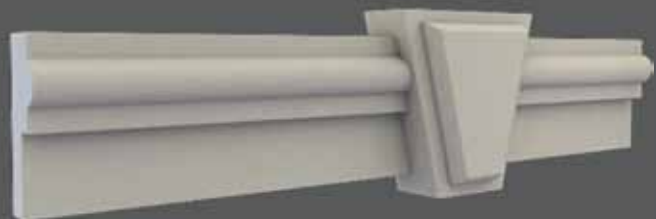

KT-05

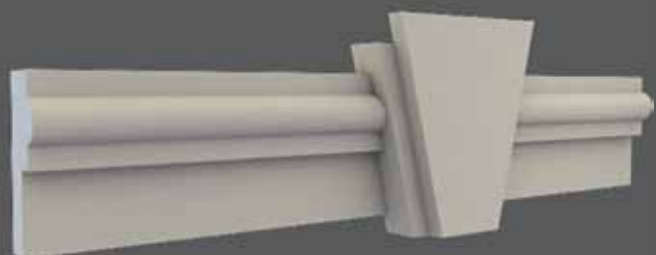

Window Frames

TAÇ-01

- * Uygulama alanına göre deęişik ölçülerde uyarlanabilir.
Depending on application surface can be produced in differend sizes



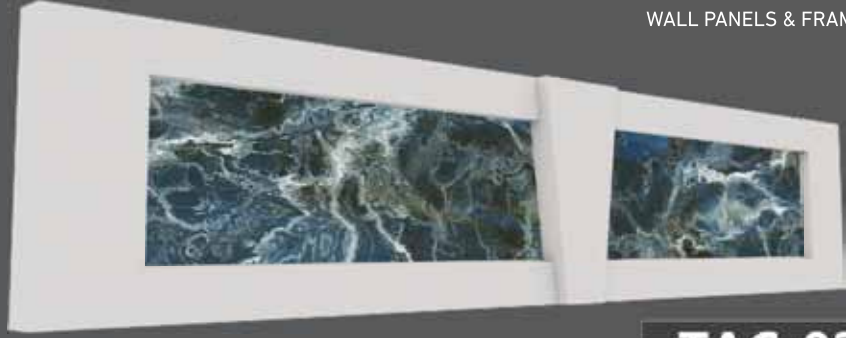

TAÇ-02

* Uygulama alanına göre değişik ölçülerde uyarlanabilir.
Depending on application surface can be produced in differend sizes

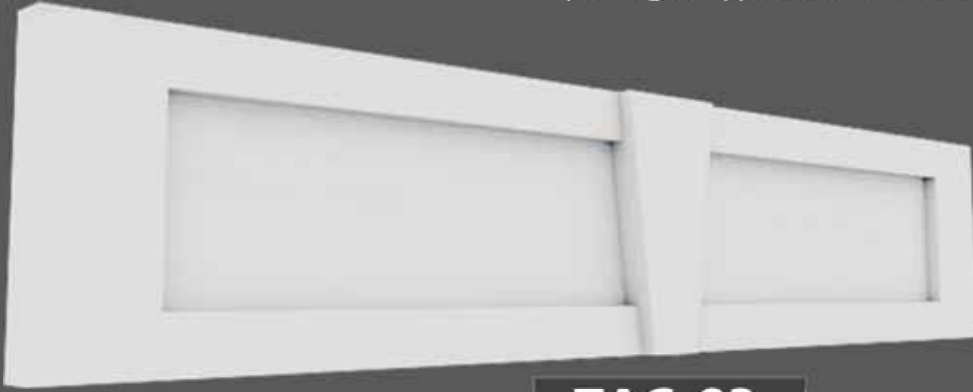

TAÇ-03

* Uygulama alanına göre değişik ölçülerde uyarlanabilir.
Depending on application surface can be produced in differend sizes



TAÇ-04

* Uygulama alanına göre değişik ölçülerde uyarlanabilir.
Depending on application surface can be produced in differend sizes



TAÇ-05

* Uygulama alanına göre değişik ölçülerde uyarlanabilir.
Depending on application surface can be produced in differend sizes

Wall Lamps

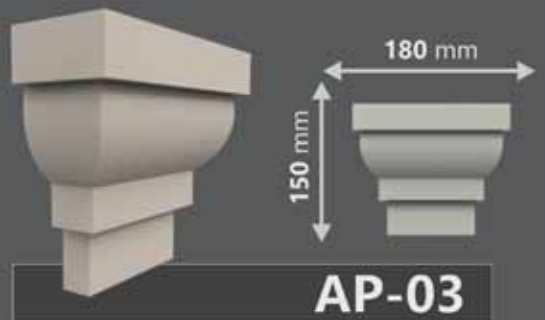
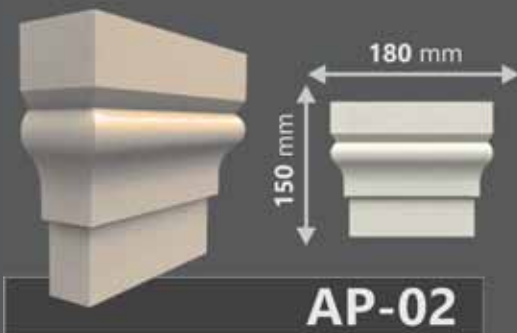
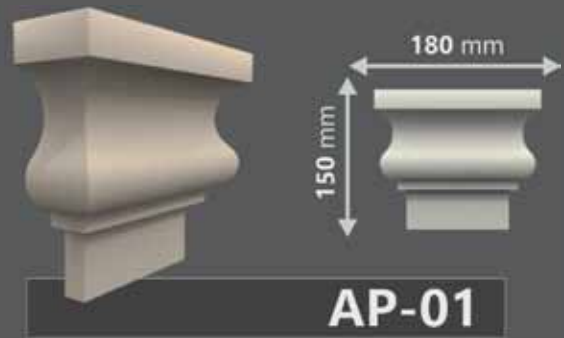

Wall Lamps

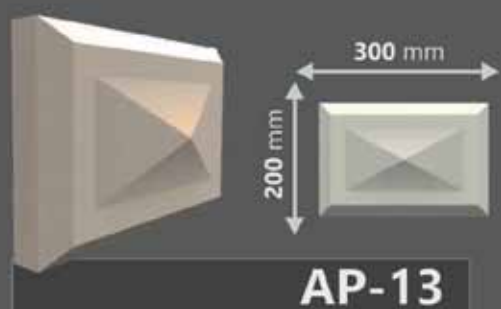
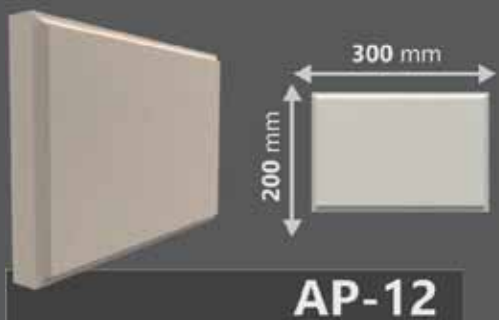
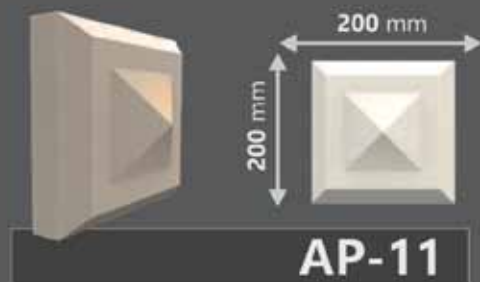
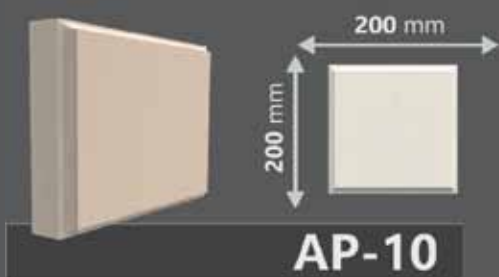
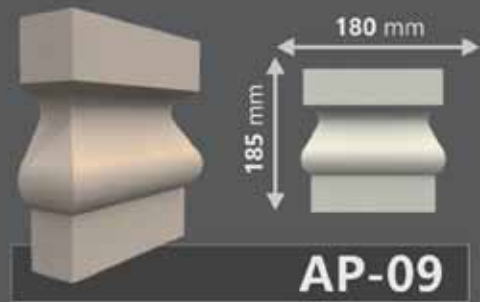
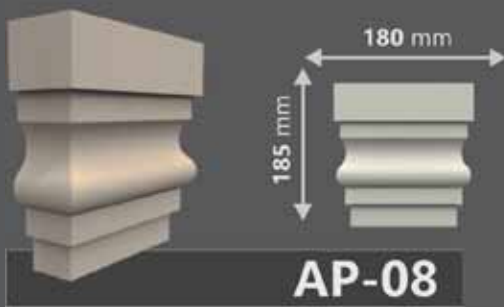
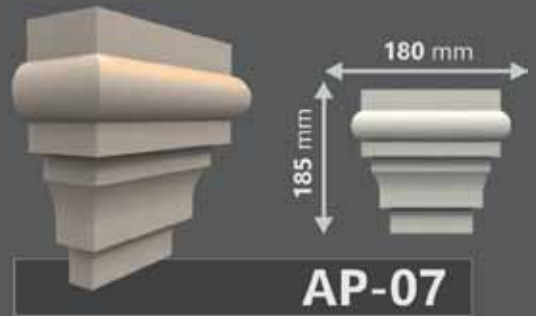
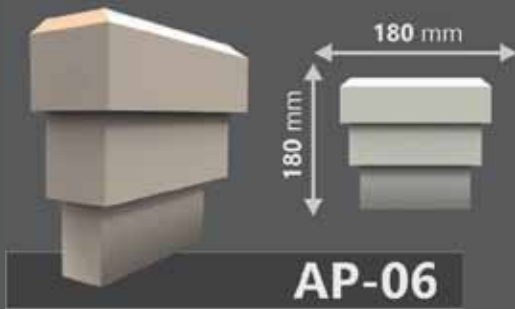
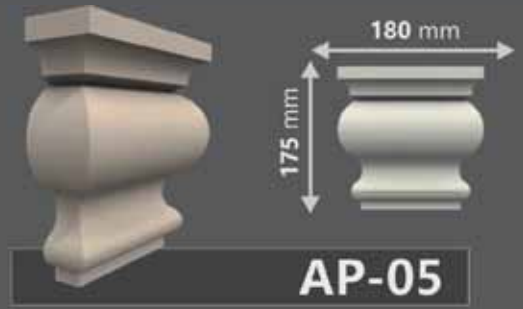
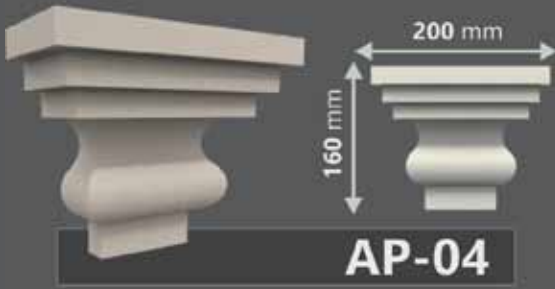



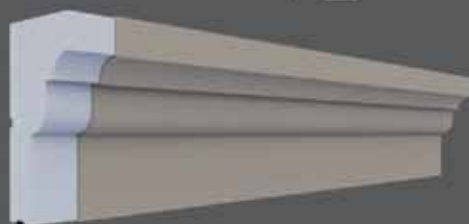
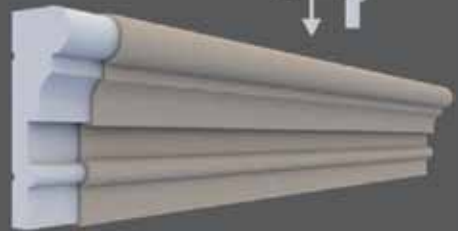
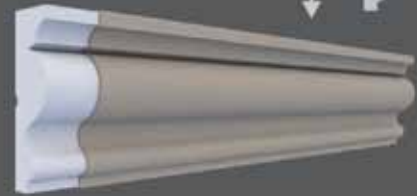
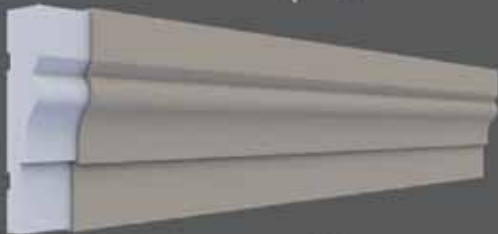
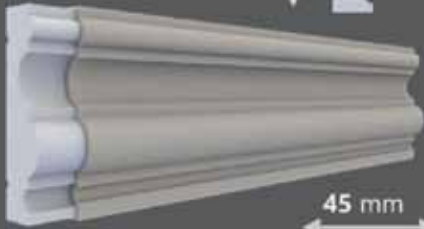

Flat Mouldings

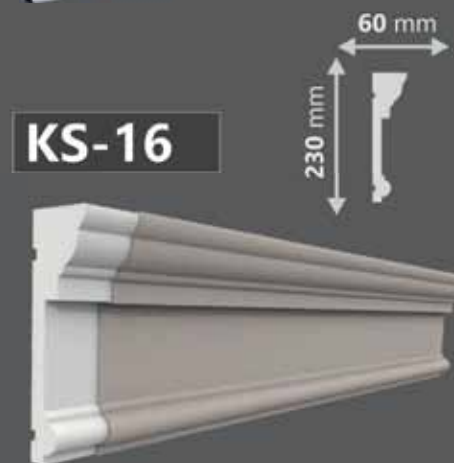
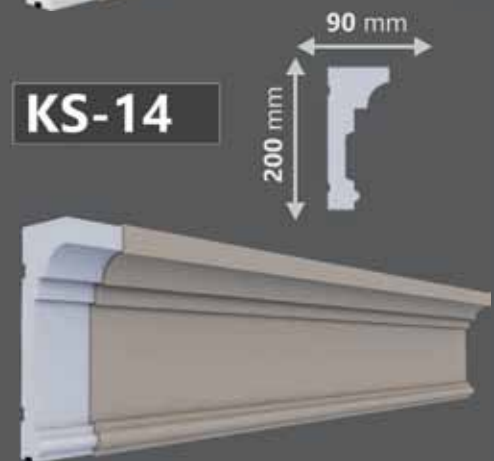
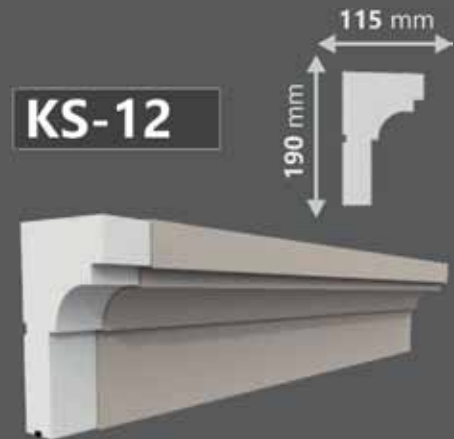
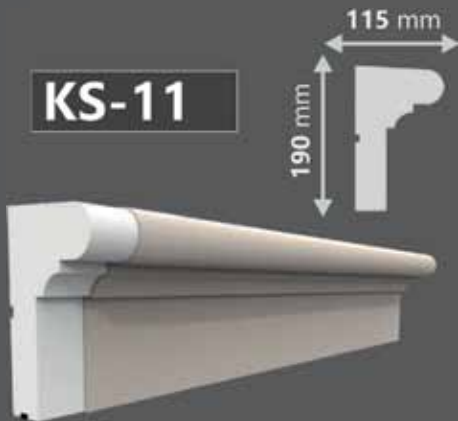
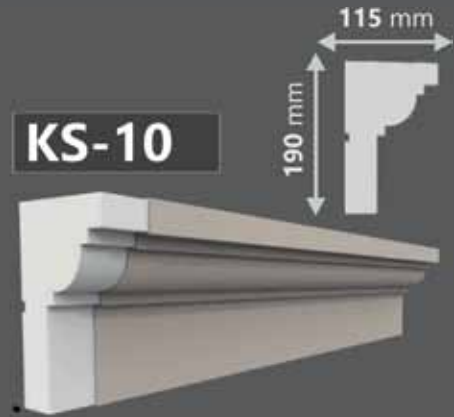
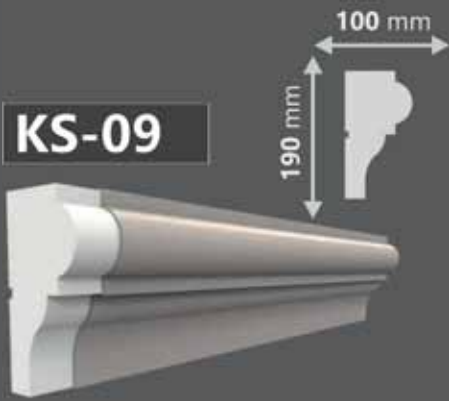

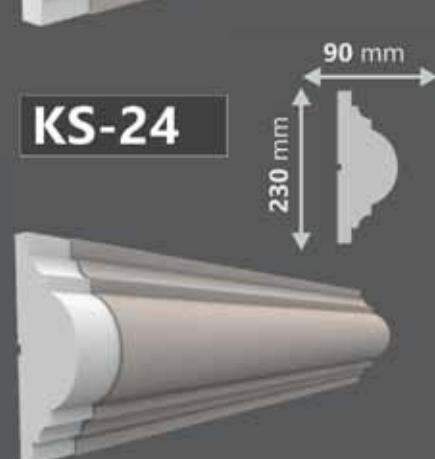
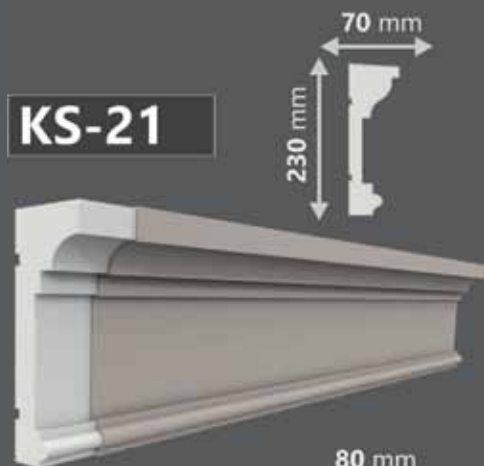
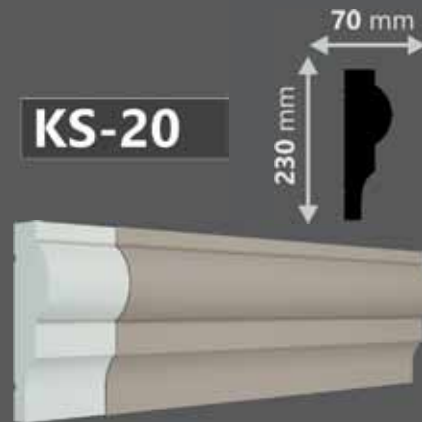

Flat Mouldings

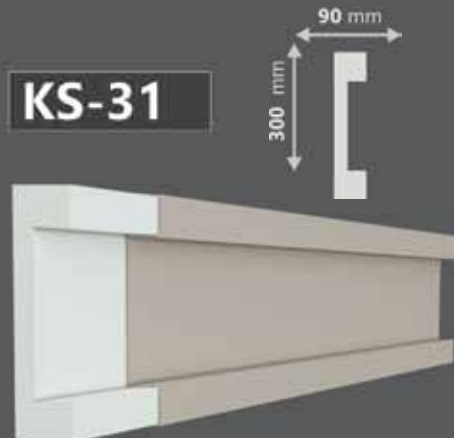
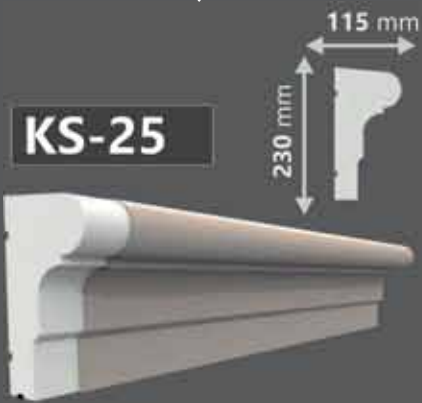



Pattern Flat Mouldings



DKS-01



DKS-02



DKS-03



DKS-04



DKS-05

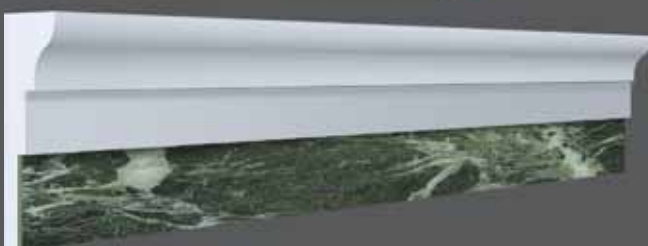

DKS-06

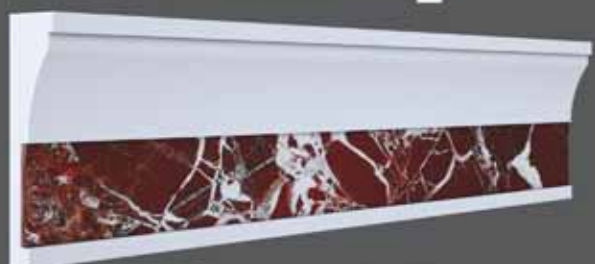

Buttresses

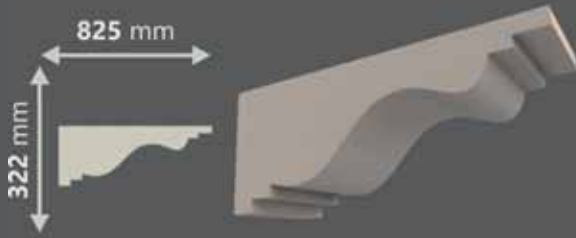

PY-01

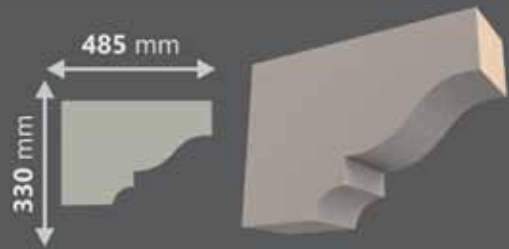

PY-02

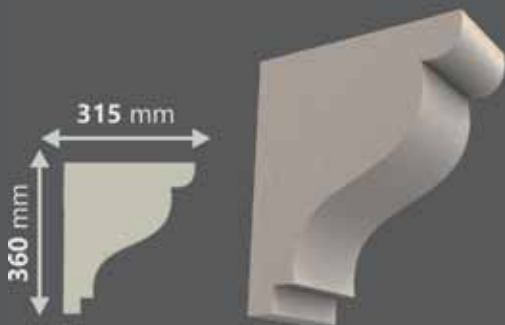

PY-03

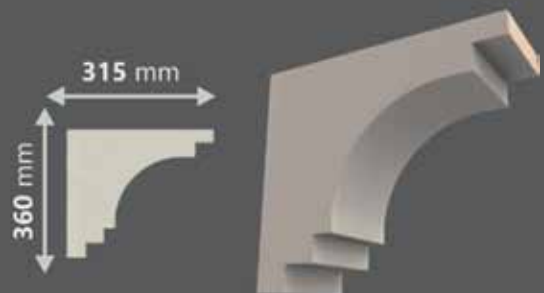

PY-04

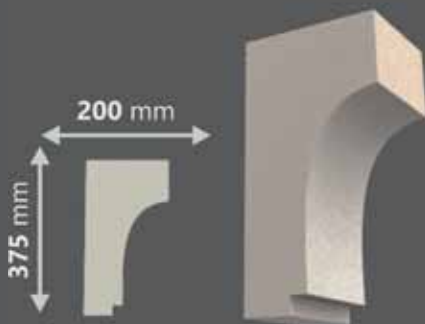

PY-05

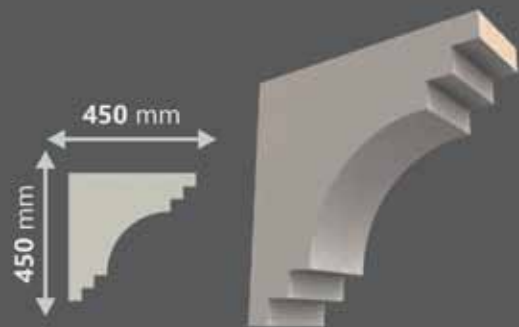

PY-06

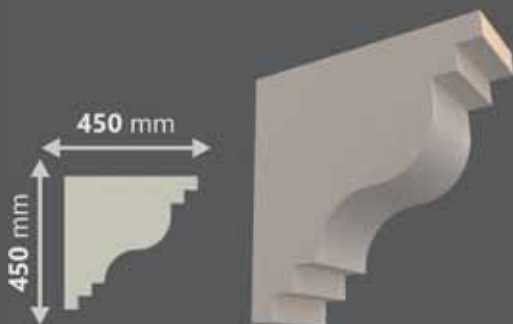

PY-07

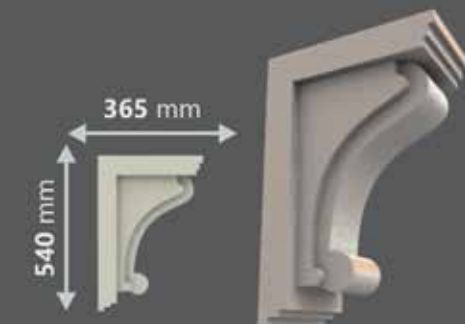

PY-08

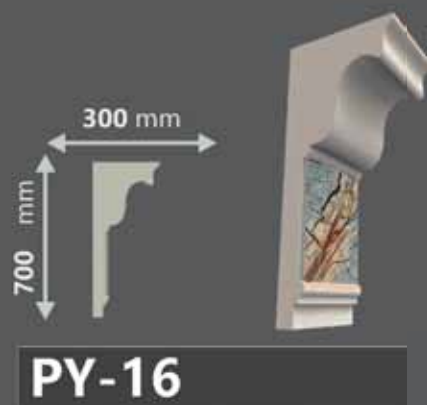
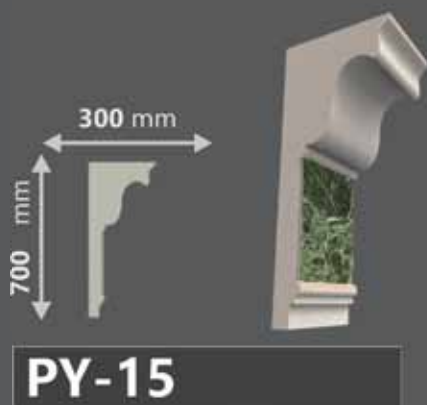
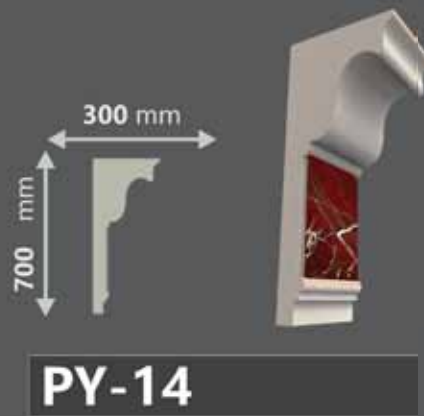
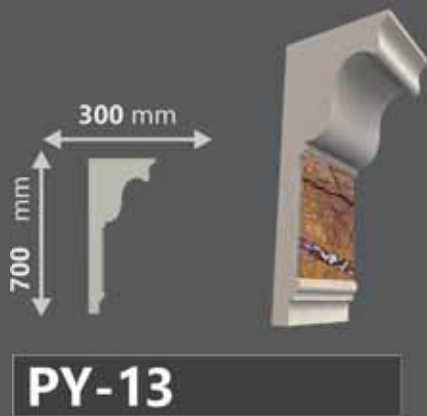
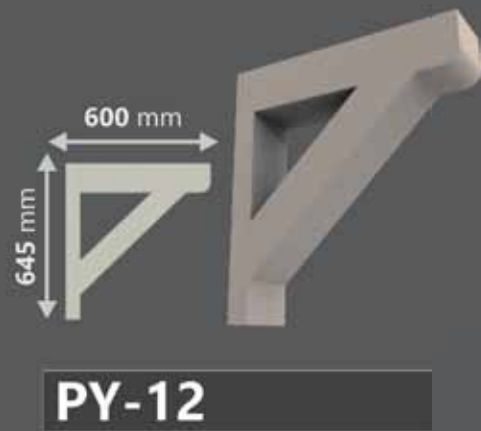
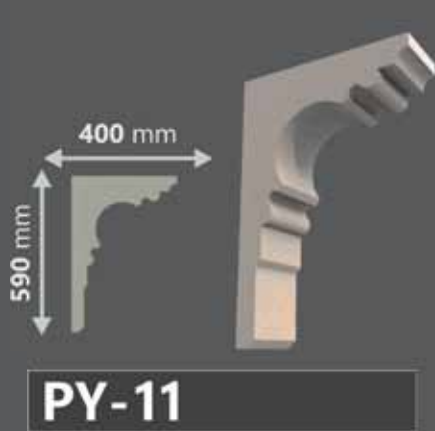
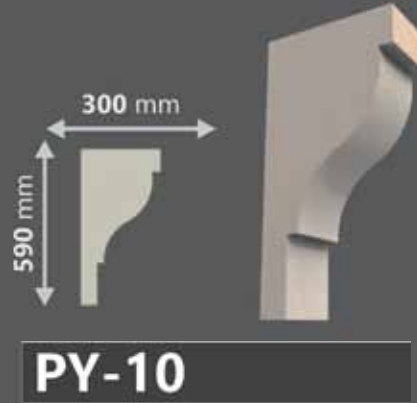
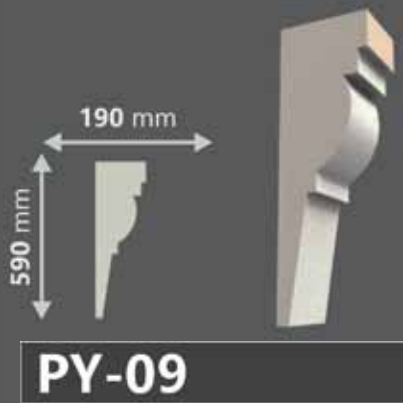



MP-01

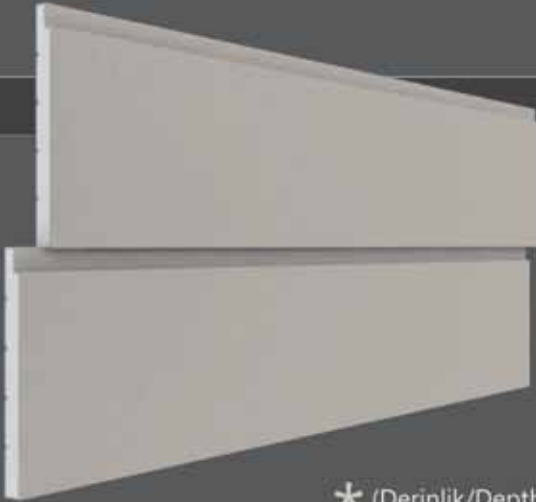
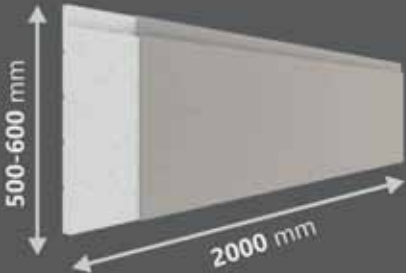

* (Derinlik/Depth) : 30-40-50-60 mm

MP-02

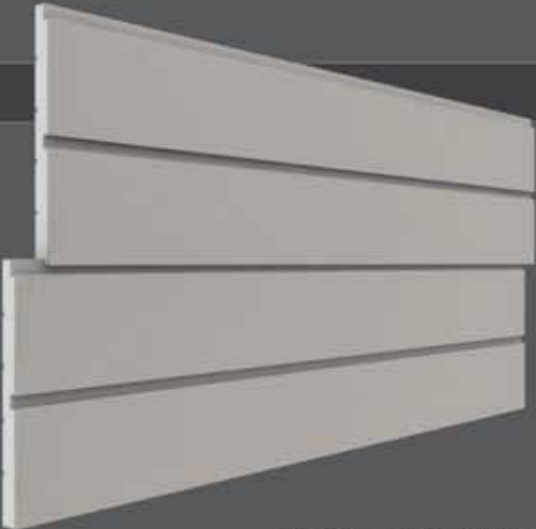
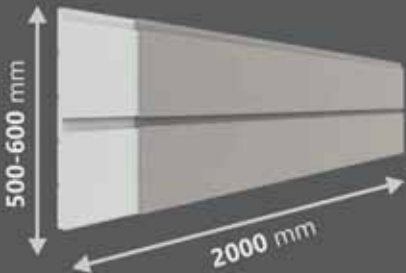

* (Derinlik/Depth) : 30-40-50-60 mm

MP-03

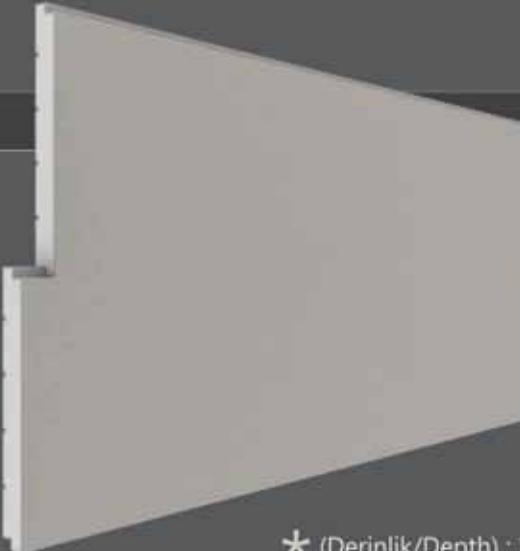
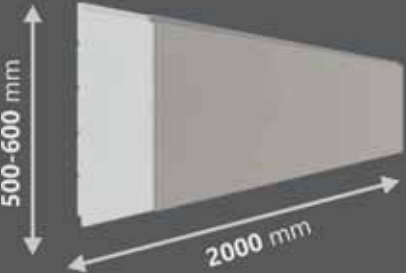

* (Derinlik/Depth) : 30-40-50-60 mm

Jacketing Plates

MP-04

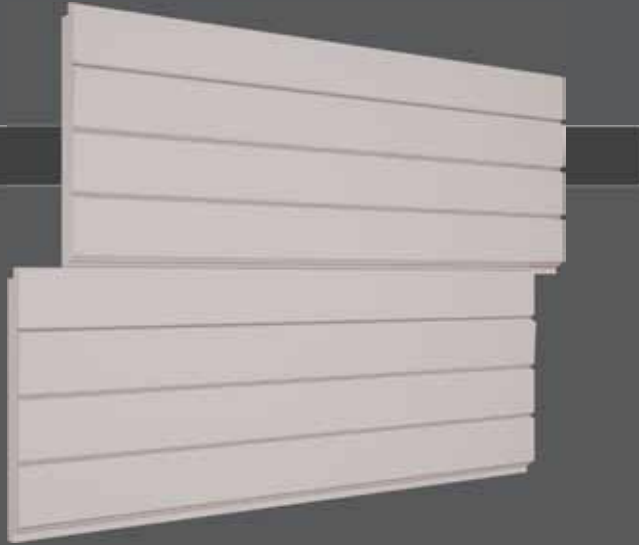
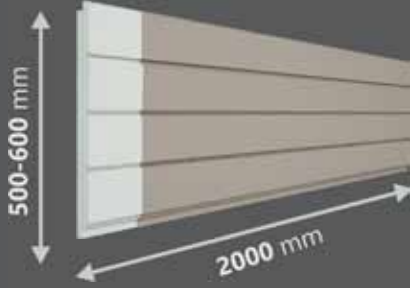

MP-05

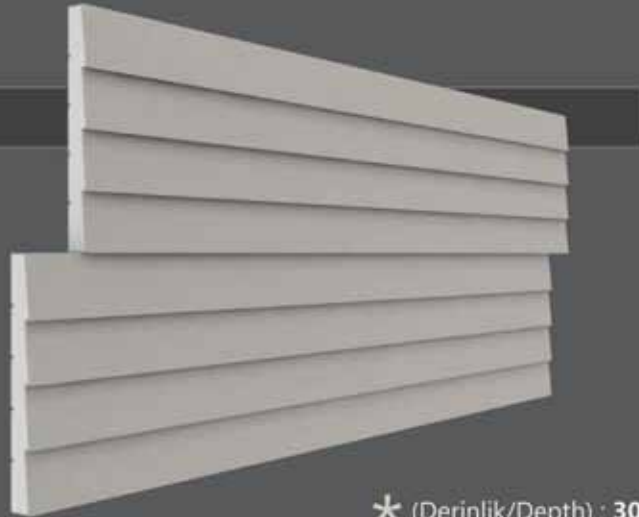
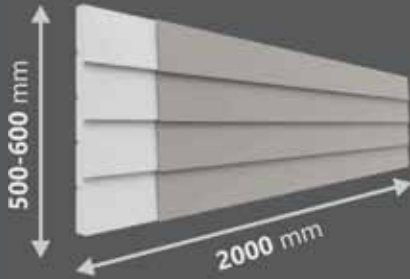

* (Derinlik/Depth) : 30-40-50 mm

MP-06

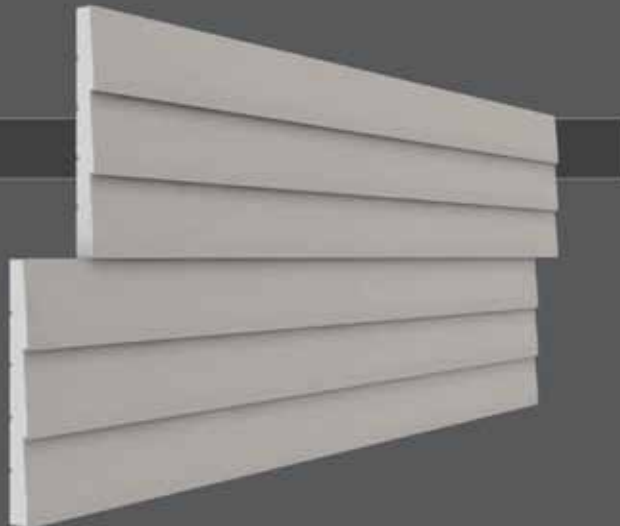
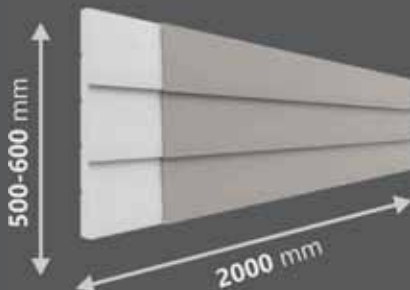

* (Derinlik/Depth) : 30-40-50 mm

MP-07

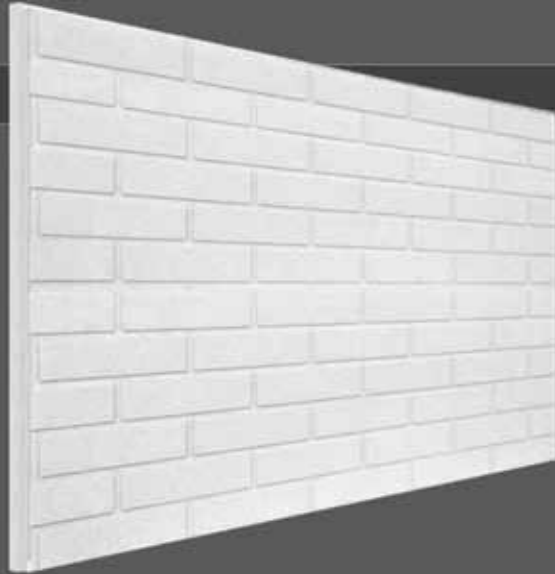
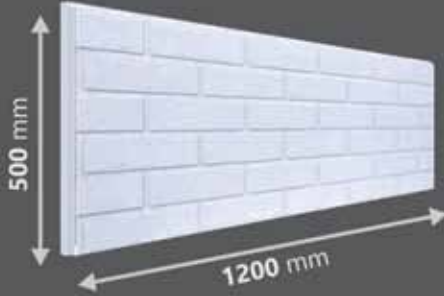

MP-08

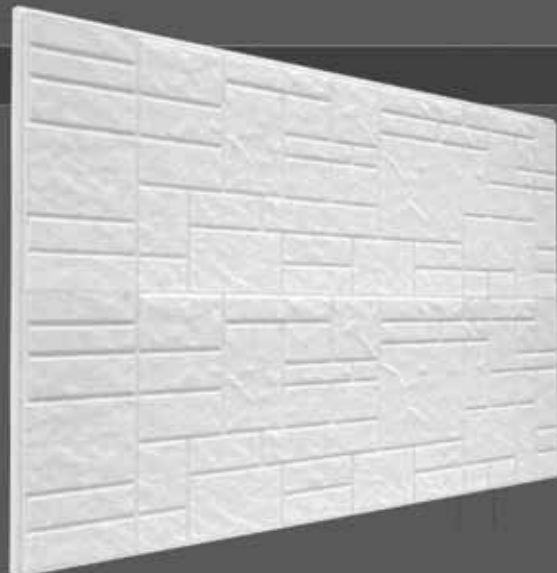
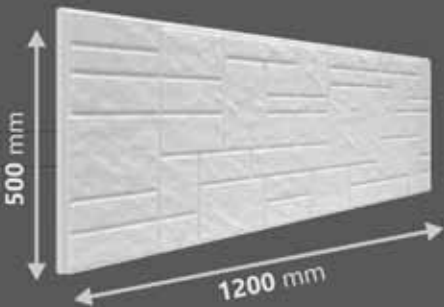

MP-09

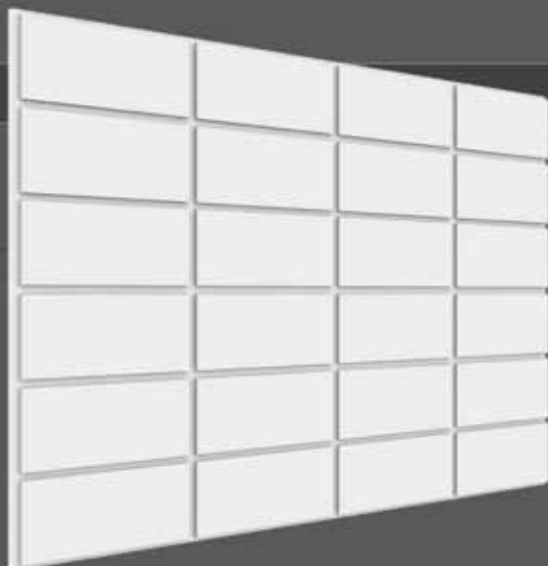
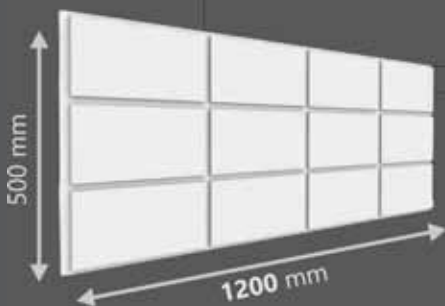

Jacketing Plates

MP-10

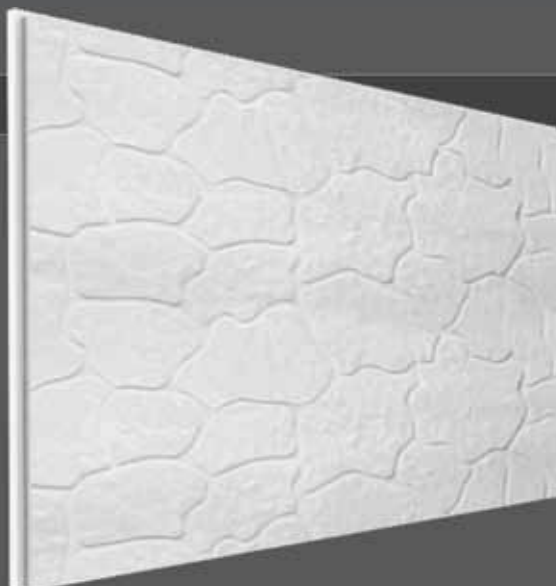
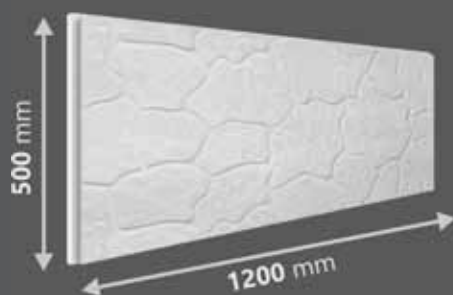

MP-11

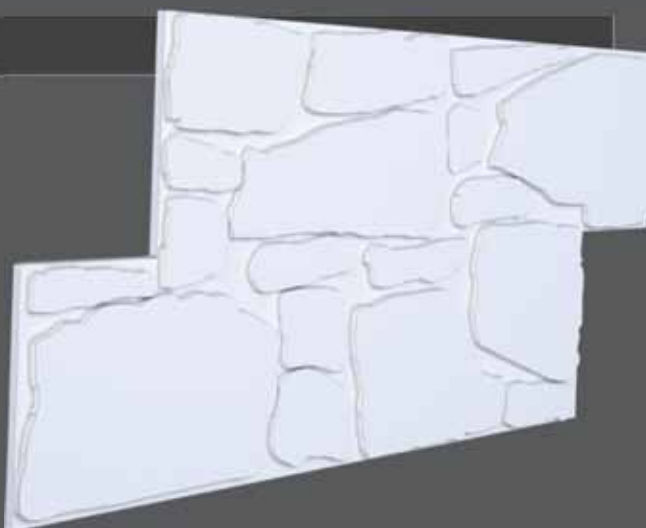
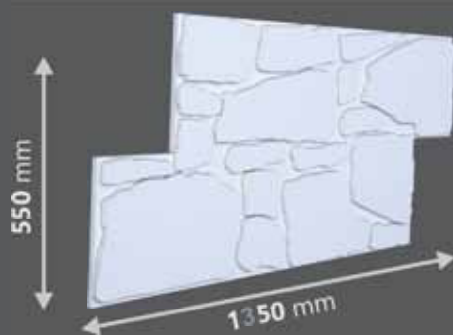



Joint Gap Lathes



FC-01

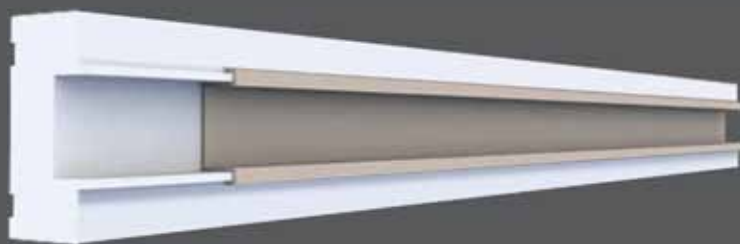
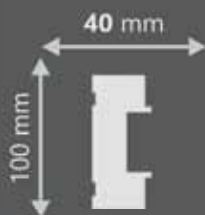

FC-02

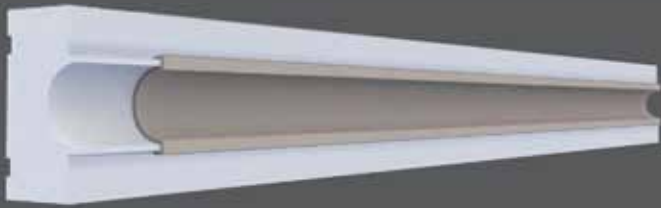
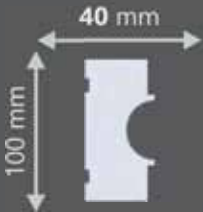

FC-03

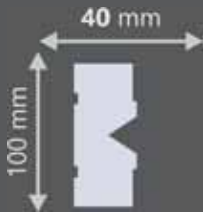

FC-04

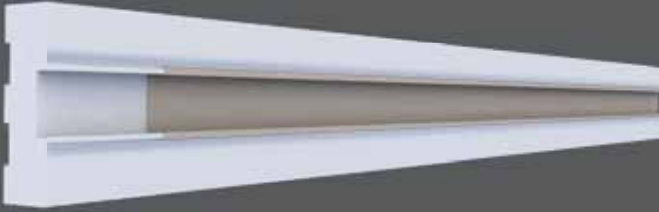
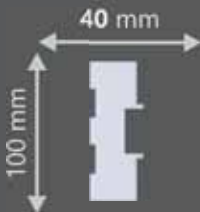

FC-05



Corner Frames





Köşe-01



Köşe-02



Köşe-03



Köşe-04

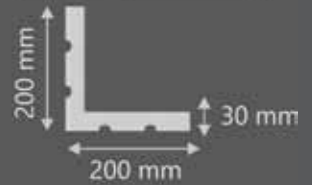
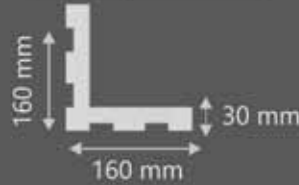
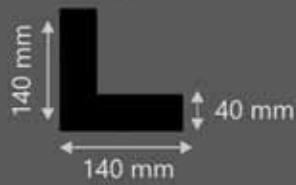

Köşe-05



Köşe-06



Köşe-07



Köşe-08





HP-01

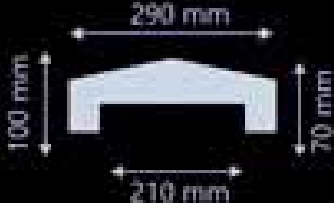

HP-02

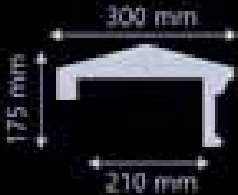

HP-03



HP-04

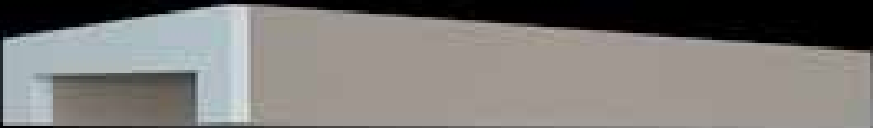



Sütun-01

(Genişlik/Width) : Uyarlanabilir/Adaptable
(Yükseklik/Height) : Uyarlanabilir/Adaptable
(Derinlik/Depth) : Uyarlanabilir/Adaptable



Sütun-02

(Genişlik/Width) : Uyarlanabilir/Adaptable
(Yükseklik/Height) : Uyarlanabilir/Adaptable
(Derinlik/Depth) : Uyarlanabilir/Adaptable



Sütun-03

(Genişlik/Width) : Uyarlanabilir/Adaptable
(Yükseklik/Height) : Uyarlanabilir/Adaptable
(Derinlik/Depth) : Uyarlanabilir/Adaptable



Sütun-04

(Genişlik/Width) : Uyarlanabilir/Adaptable
(Yükseklik/Height) : Uyarlanabilir/Adaptable
(Derinlik/Depth) : Uyarlanabilir/Adaptable



Sütun-05

(Genişlik/Width) : Uyarlanabilir/Adaptable
(Yükseklik/Height) : Uyarlanabilir/Adaptable
(Derinlik/Depth) : Uyarlanabilir/Adaptable



ST -01

*Ölçüler Uyarlanabilir
Dimensions Can Be Adaptable



ST -02

*Ölçüler Uyarlanabilir
Dimensions Can Be Adaptable



ST -03

*Ölçüler Uyarlanabilir
Dimensions Can Be Adaptable



Powered by
VERLASS
CONSTRUCTION AND CHEMICALS

RECESS[®]



+90 212 672 89 12
www.verlass.com.tr

Enverpaşa Cad. E 12 Blok D.2 Esenkent / İSTANBUL
TÜRKİYE

RECESS[®] logosu ve markası Verlass Yapı ve Kimya San. Tic. Ltd. Şti.'nin ticari ve tescilli markasıdır. Her hakkı Saklıdır.
The RECESS[®] logo and brand is Verlass Construction and Chemical Trade Ltd. Company's commercial and proprietary trademark. All rights reserved.